

Attachment D

Shadow Analysis and Sun Eye Diagrams

LEGEND:
 - - COMPLIANT 12M HIGH BUILDING ENVELOPE
 - - EXISTING WALL APPROX. 4m HIGH, (HEIGHT TO BE CHECKED ON SITE)

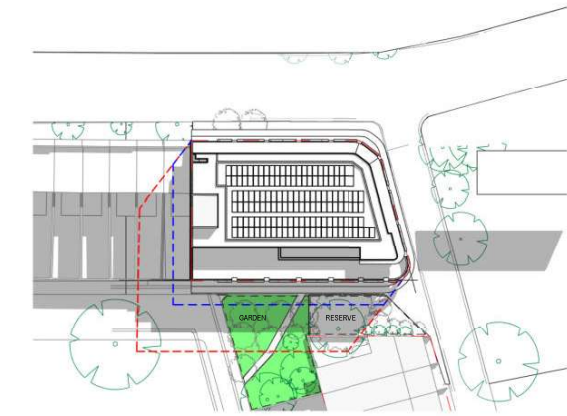

1 Shadows (Equinox)-21 March 9.00am
1:500

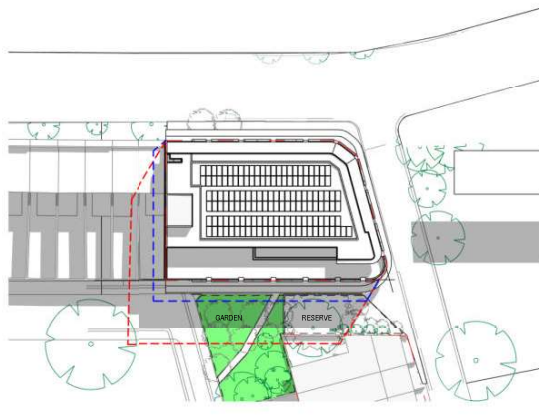

2 Shadows (Equinox)-21 March 9.30am
1:500

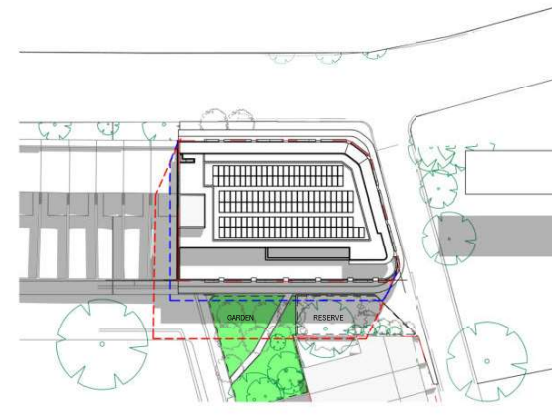

3 Shadows (Equinox)-21 March 10.00am
1:500

176

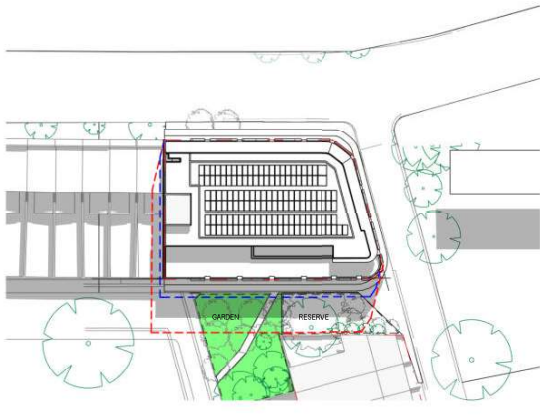

4 Shadows (Equinox)-21 March 10.30am
1:500

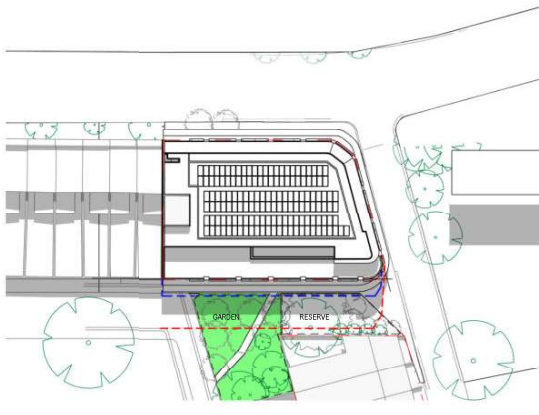

5 Shadows (Equinox)-21 March 11.00am
1:500

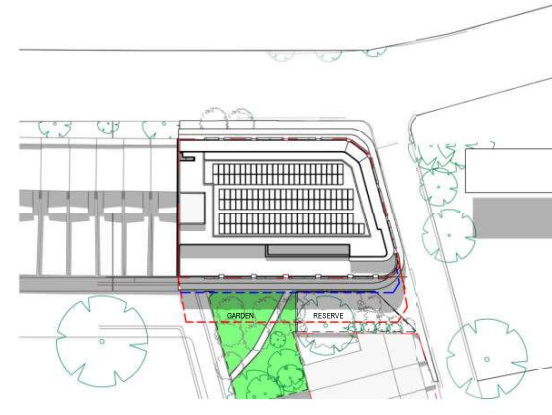

6 Shadows (Equinox)-21 March 11.30am
1:500

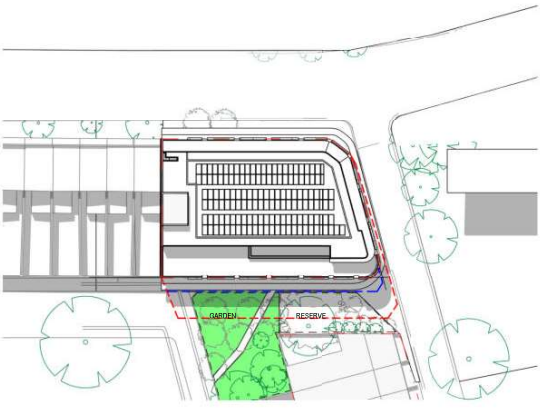

7 Shadows (Equinox)-21 March 12.00pm
1:500

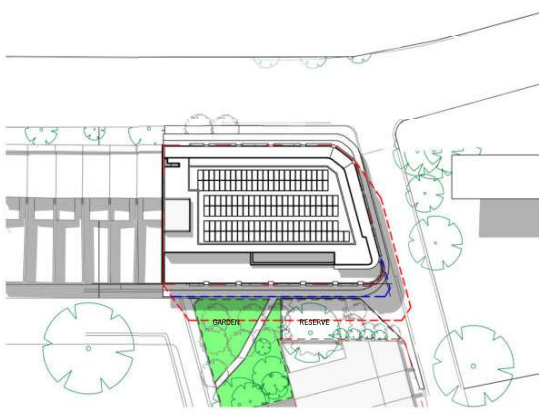

8 Shadows (Equinox)-21 March 12.30pm
1:500



9 Shadows (Equinox)-21 March 13.00pm
1:500

REV	DESCRIPTION	DATE	APP.
1	ISSUED TO COUNCIL	07.03.24	AC
2	ISSUED TO COUNCIL	15.05.24	AC

Client
STASIA PTY LTD

Project
Cleveland St Mixed Use

Drawing
SHADOW DIAGRAMS - EQUINOX

A1 Scale As indicated
Project 220098
Issue 2

Number DD - DR - AR - DA 318

Details
Copyright Conrad Gargett, ACN 636 465 373 ABN 61 636 465 373
Do not scale this drawing and verify all dimensions and levels on site.
Nominated Architect: Lawrence Toole NSW Reg. 10255,
Nominated Architect: Brian Cookson NSW Reg. 11726,
Nominated Architect: Laura Cookburn NSW Reg. 6360.



DEVELOPMENT APPROVAL



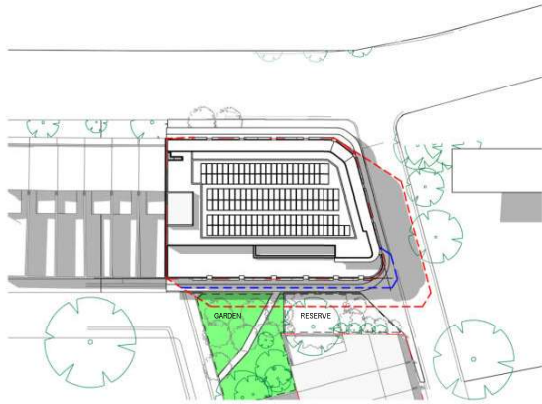

1 Shadows (Equinox)-21 March 13.30pm
1:100

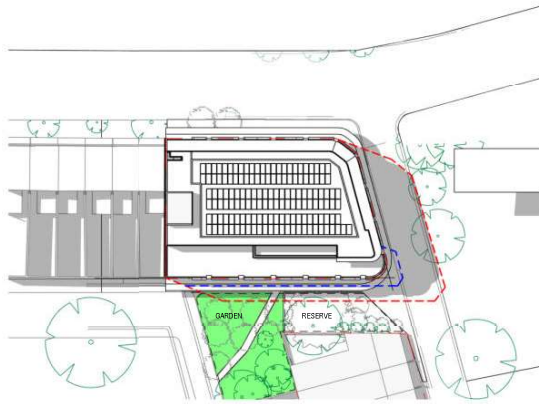

2 Shadows (Equinox)-21 March 14.00pm
1:100

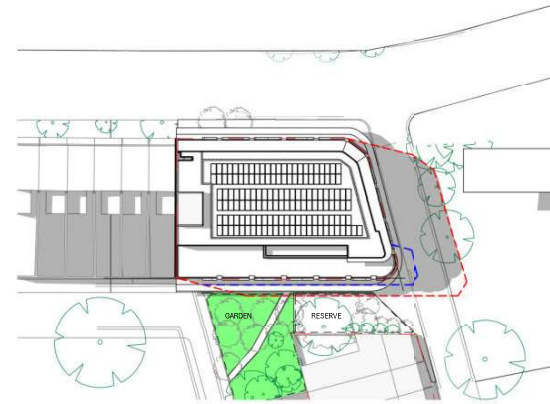

3 Shadows (Equinox)-21 March 14.30pm
1:100

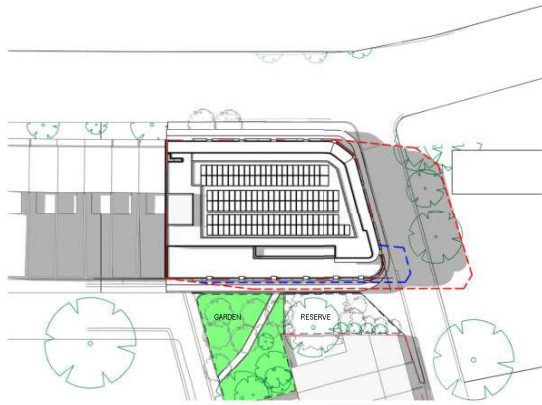

4 Shadows (Equinox)-21 March 15.00pm
1:100

177

LEGEND:
 - - - COMPLIANT 12M HIGH BUILDING ENVELOPE
 - - - EXISTING WALL APPROX. 4m HIGH, (HEIGHT TO BE CHECKED ON SITE)

Revision	REV	DESCRIPTION	DATE	APP.
1	ISSUED TO COUNCIL	07.03.24	AC	
2	ISSUED TO COUNCIL	15.05.24	AC	

Client
STASIA PTY LTD

Project
Cleveland St Mixed Use

Drawing
SHADOW DIAGRAMS - EQUINOX

A1 Scale As indicated 
Project 220098
Issue 2

Number DD - DR - AR - DA 319

Details
 Copyright Conrad Gargett, ACN 636 455 373 ABN 61 631 465 375
 Do not scale this drawing and verify all dimensions and levels on site.
 Nominated Architect: Lawrence Toole NSW Reg. 10255,
 Nominated Architect: Orlan Condon NSW Reg. 11726,
 Nominated Architect: Laura Cookburn NSW Reg. 6360.



DEVELOPMENT APPROVAL

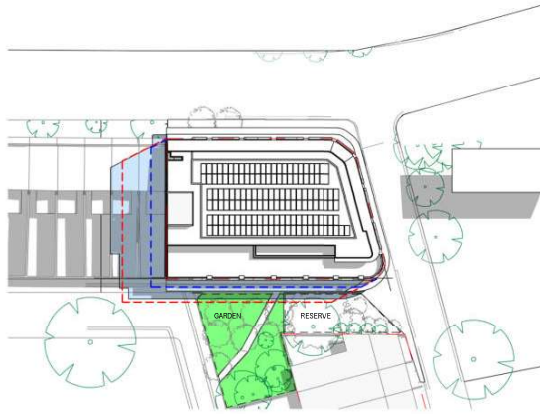

1 Shadows (Summer)-21 December 9:00am
1:500

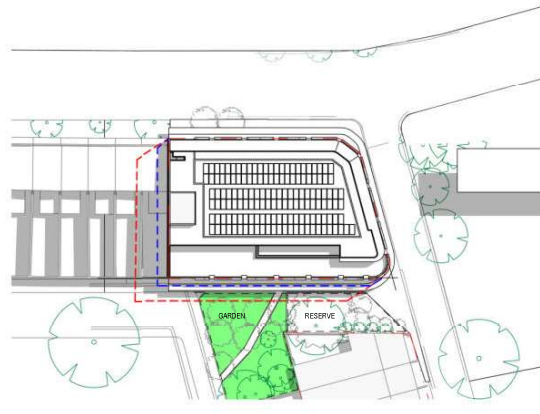

2 Shadows (Summer)-21 December 9:30am
1:500

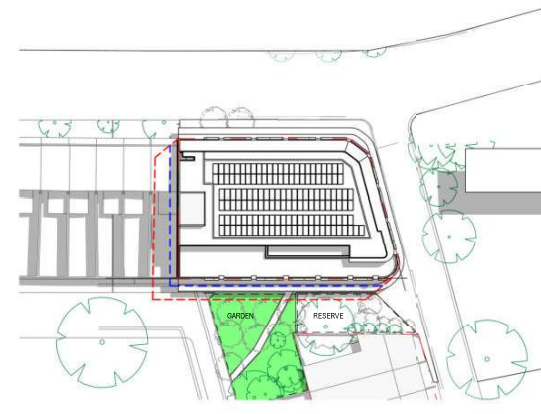

3 Shadows (Summer)-21 December 10:00am
1:500

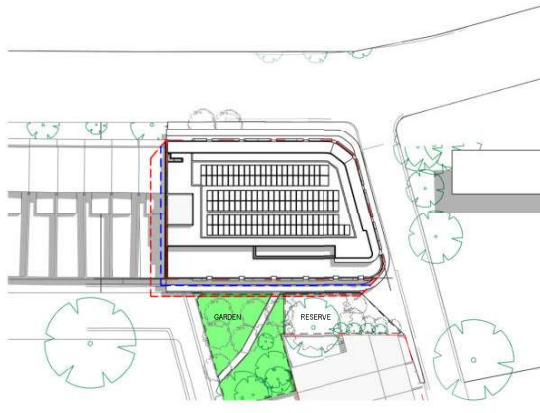

4 Shadows (Summer)-21 December 10:30am
1:500

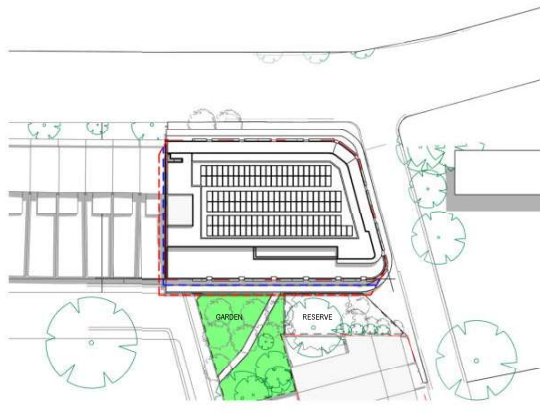

5 Shadows (Summer)-21 December 11:00am
1:500

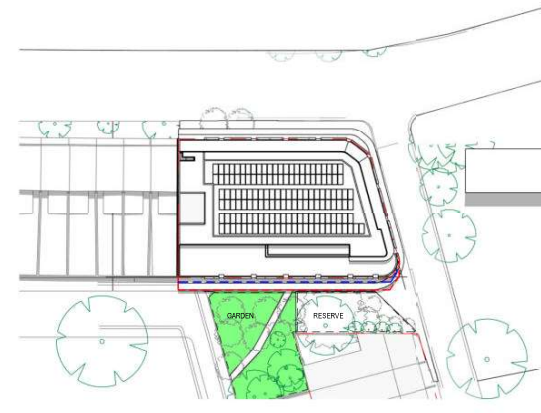

6 Shadows (Summer)-21 December 11:30am
1:500

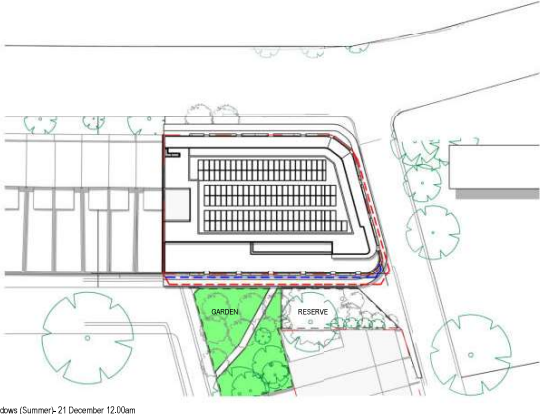

7 Shadows (Summer)-21 December 12:00pm
1:500

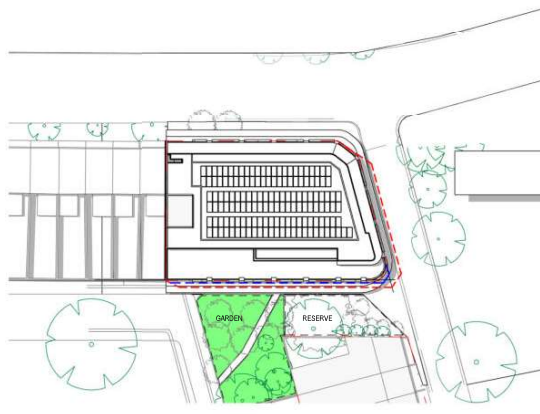

8 Shadows (Summer)-21 December 12:30pm
1:500

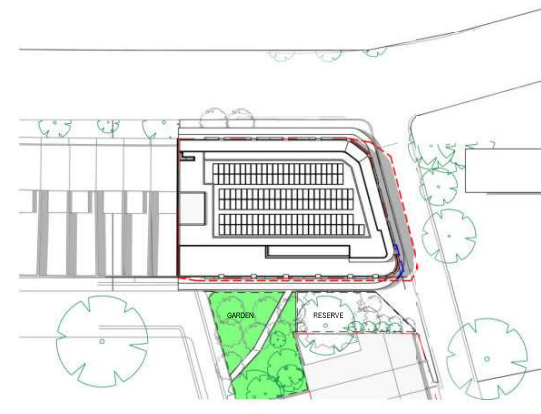

9 Shadows (Summer)-21 December 13:00pm
1:500

LEGEND:
 - - - COMPLIANT 12M HIGH BUILDING ENVELOPE
 - - - EXISTING WALL APPROX. 4m HIGH, (HEIGHT TO BE CHECKED ON SITE)

178

REV	DESCRIPTION	DATE	APP.
1	ISSUED FOR DA	20.06.23	AC
2	ISSUED TO COUNCIL	07.03.24	AC
3	ISSUED TO COUNCIL	15.02.24	AC

Client
STASIA PTY LTD

Project
Cleveland St Mixed Use

Drawing
**SHADOW DIAGRAMS -
SUMMER**

A1 Scale As indicated
Project 220098
Issue 3

Number DD - DR - AR - DA 320

Details
Copyright Conrad Gargett. ACN 636 465 373 ABN 61 636 465 373
Nominated Architect: Lawrence Toaloo NSW Reg. 10255,
Nominated Architect: Orlan Condon NSW Reg. 11726,
Nominated Architect: Laura Cookburn NSW Reg. 6361.



DEVELOPMENT APPROVAL



LEGEND:
 - - - COMPLIANT 12M HIGH BUILDING ENVELOPE
 - - - EXISTING WALL APPROX. 4m HIGH, (HEIGHT TO BE CHECKED ON SITE)

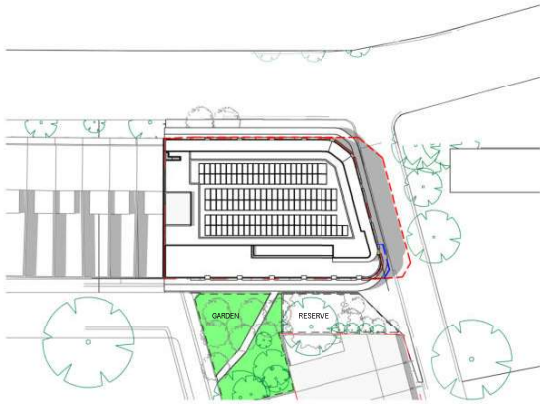

1 Shadows (Summer)-21 December 13.30pm
1:100

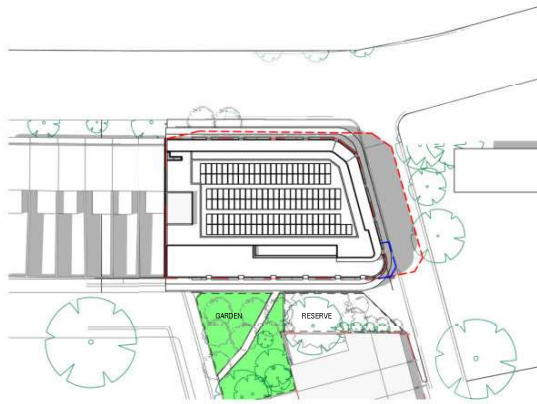

2 Shadows (Summer)-21 December 14.00pm
1:100



3 Shadows (Summer)-21 December 14.30pm
1:100

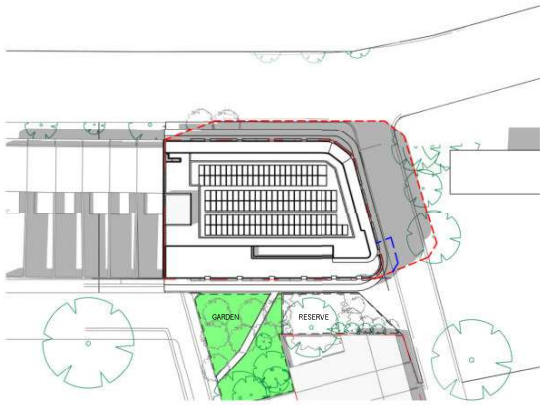

4 Shadows (Summer)-21 December 15.00pm
1:100

179

REV	DESCRIPTION	DATE	APP.
1	ISSUED TO COUNCIL	07.03.24	AC
2	ISSUED TO COUNCIL	15.05.24	AC

Client
STASIA PTY LTD

Project
Cleveland St Mixed Use

Drawing
SHADOW DIAGRAMS -
SUMMER

A1 Scale As indicated 
Project 220098
Issue 2

Number DD - DR - AR - DA 321

Details
Copyright Conrad Gargett, ACN 636 465 373 ABN 61 636 465 375
Do not scale this drawing and verify all dimensions and levels on site.
Nominated Architect: Lawrence Totho NSW Reg. 10255,
Nominated Architect: Orlan Condon NSW Reg. 11726,
Nominated Architect: Laura Cookburn NSW Reg. 6360.



DEVELOPMENT APPROVAL

LEGEND:
 - - COMPLIANT 12M HIGH BUILDING ENVELOPE
 - - EXISTING WALL APPROX. 4m HIGH, (HEIGHT TO BE CHECKED ON SITE)

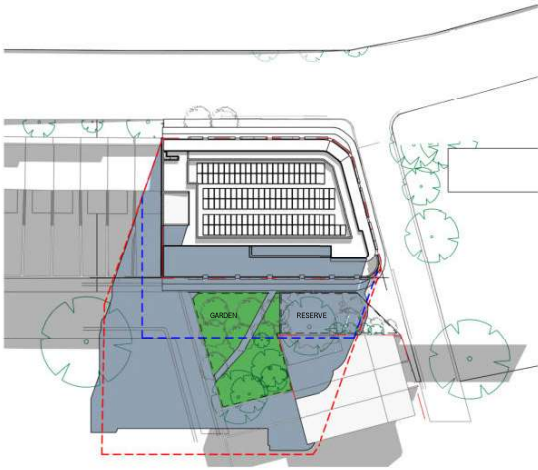

1 Shadows (Winter)-23 June 9.00am
1:500

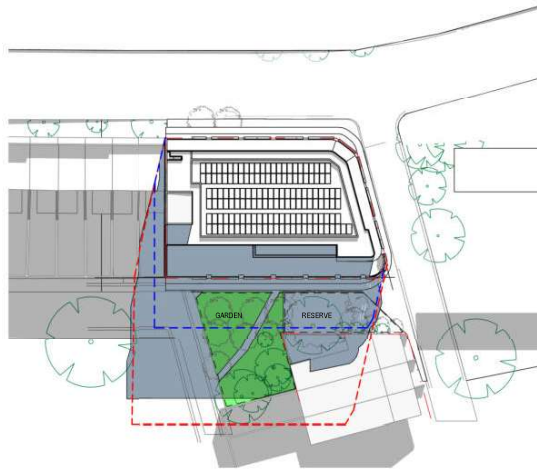

2 Shadows (Winter)-23 June 9.30am
1:500

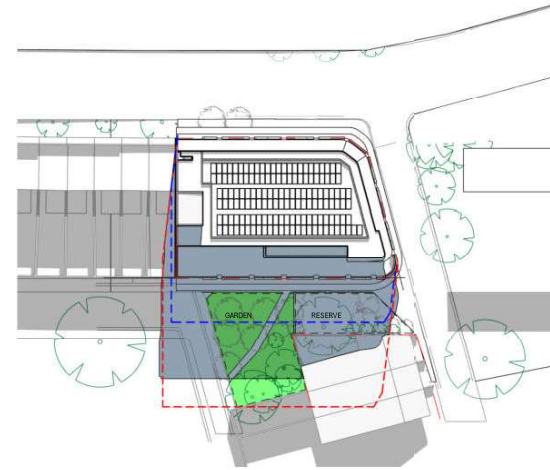

3 Shadows (Winter)-23 June 10.00am
1:500

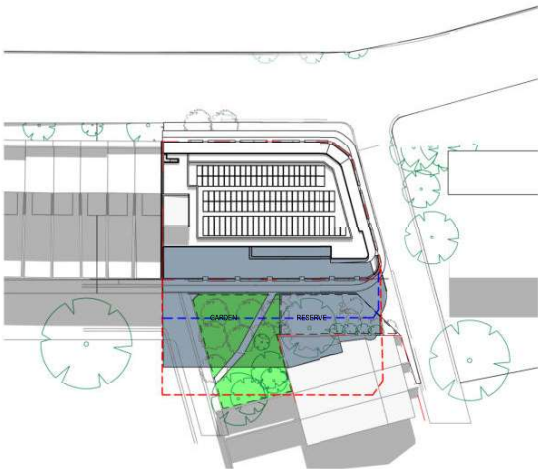

4 Shadows (Winter)-23 June 10.30am
1:500

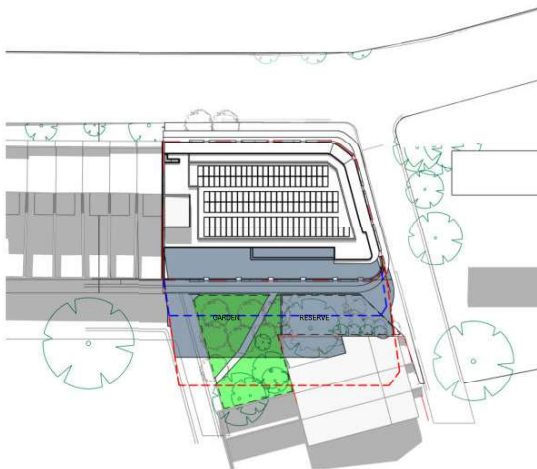

5 Shadows (Winter)-23 June 11.00am
1:500

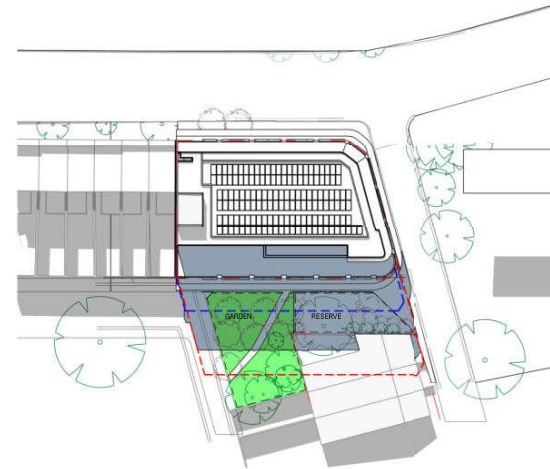

6 Shadows (Winter)-23 June 11.30am
1:500

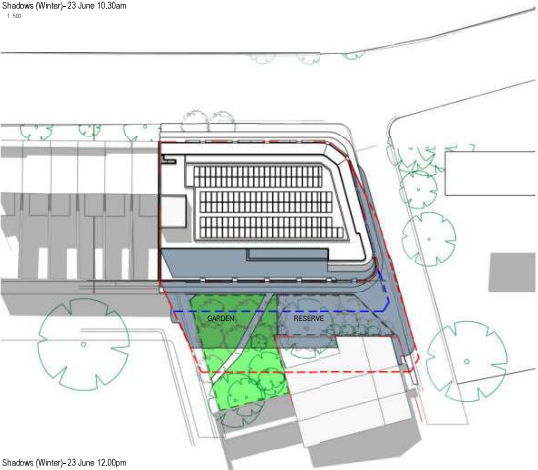

7 Shadows (Winter)-23 June 12.00pm
1:500

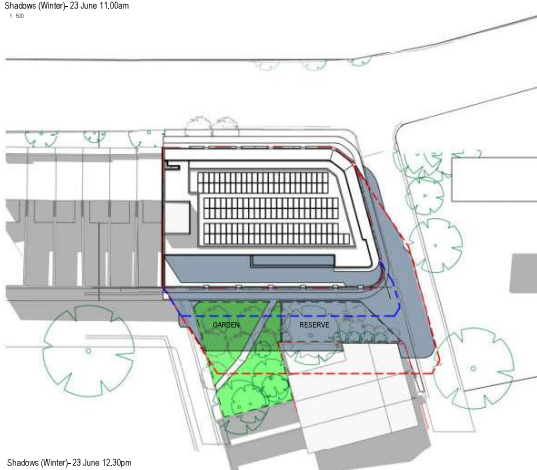

8 Shadows (Winter)-23 June 12.30pm
1:500

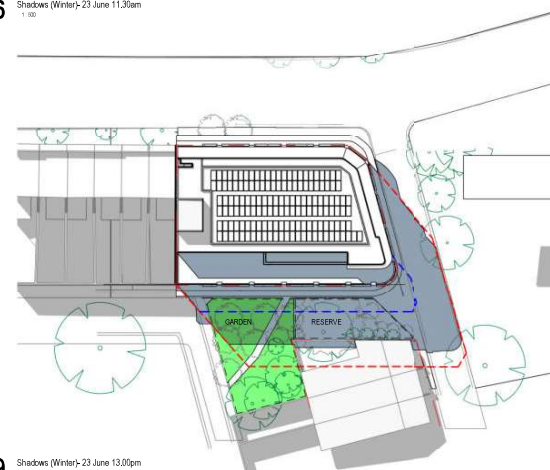

9 Shadows (Winter)-23 June 13.00pm
1:500

180

REV	DESCRIPTION	DATE	APP.
1	ISSUED TO COUNCIL	07.23.24	AC
2	ISSUED TO COUNCIL	12.24.24	AC
3	ISSUED TO COUNCIL	15.26.24	AC

Client
STASIA PTY LTD

Project
Cleveland St Mixed Use

Drawing
SHADOW DIAGRAMS - WINTER

A1 Scale As indicated

Project 220098

Issue 3

Number DD - DR - AR - DA 322

Details
Copyright Conrad Gargett. ACN 636 455 373 ABN 61 636 455 373
Do not scale this drawing and verify all dimensions and levels on site.
Nominated Architect: Lawrence Tomko NSW Reg. 10255.
Nominated Architect: Gillian Condon NSW Reg. 11726.
Nominated Architect: Laura Cookburn NSW Reg. 6360.



DEVELOPMENT APPROVAL

LEGEND:
 - - - COMPLIANT 12M HIGH BUILDING ENVELOPE
 - - - EXISTING WALL APPROX. 4m HIGH, (HEIGHT TO BE CHECKED ON SITE)

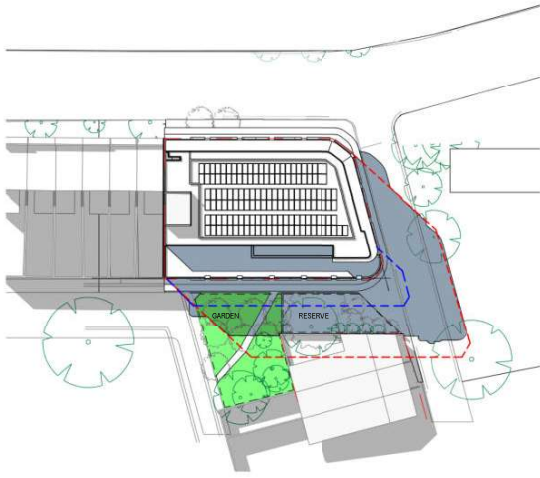

1 Shadows (Winter)-23 June 13.30 pm
1:50

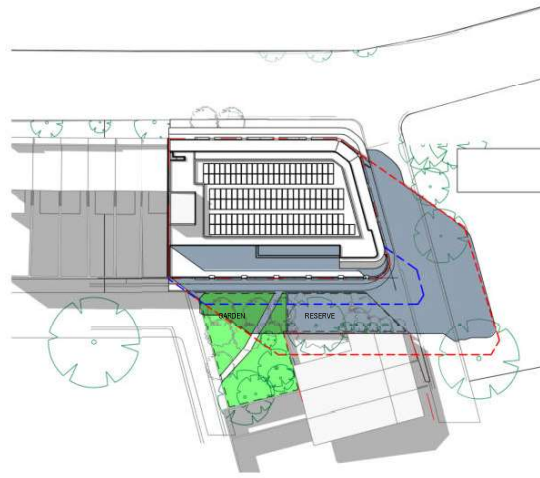

2 Shadows (Winter)-23 June 14.00 pm
1:50

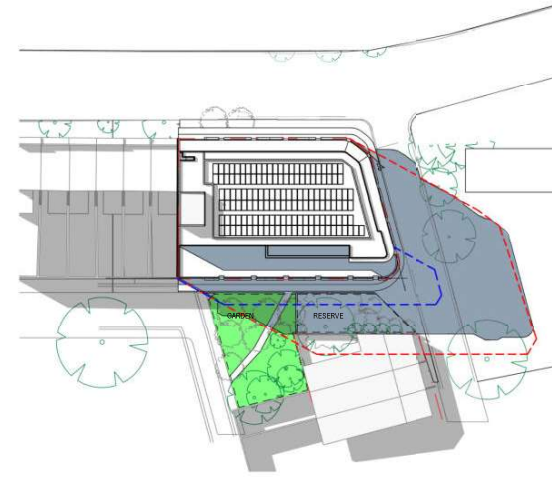

3 Shadows (Winter)-23 June 14.30 pm
1:50

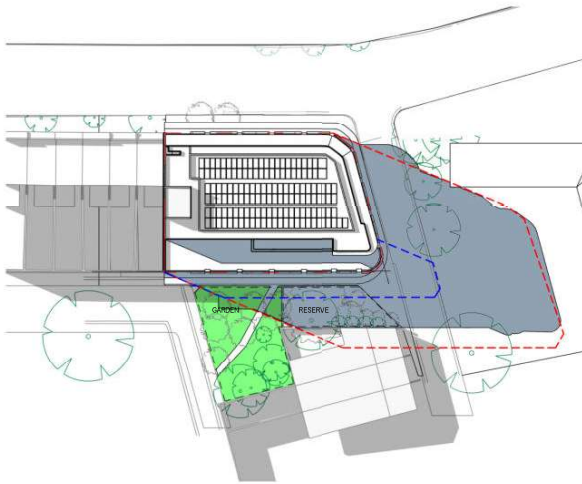

4 Shadows (Winter)-23 June 15.00pm
1:50

181

REV	DESCRIPTION	DATE	APP.
1	ISSUED TO COUNCIL	14.11.23	AC
2	ISSUED TO COUNCIL	07.05.24	AC
3	ISSUED TO COUNCIL	12.04.24	AC
4	ISSUED TO COUNCIL	15.05.24	AC

Client
STASIA PTY LTD

Project
Cleveland St Mixed Use

Drawing
SHADOW DIAGRAMS - WINTER

A1 Scale As indicated
 Project 220098
 Issue 4

Number DD - DR - AR - DA 323

Details
 Copyright Conrad Gargett. ACN 636 465 373 ABN 61 636 465 373
 Do not scale this drawing and verify all dimensions and levels on site.
 Nominated Architect: Lawrence Tomko NSW Reg. 10255,
 Nominated Architect: Ollian Condon NSW Reg. 11726,
 Nominated Architect: Laura Cookburn NSW Reg. 6360.



DEVELOPMENT APPROVAL

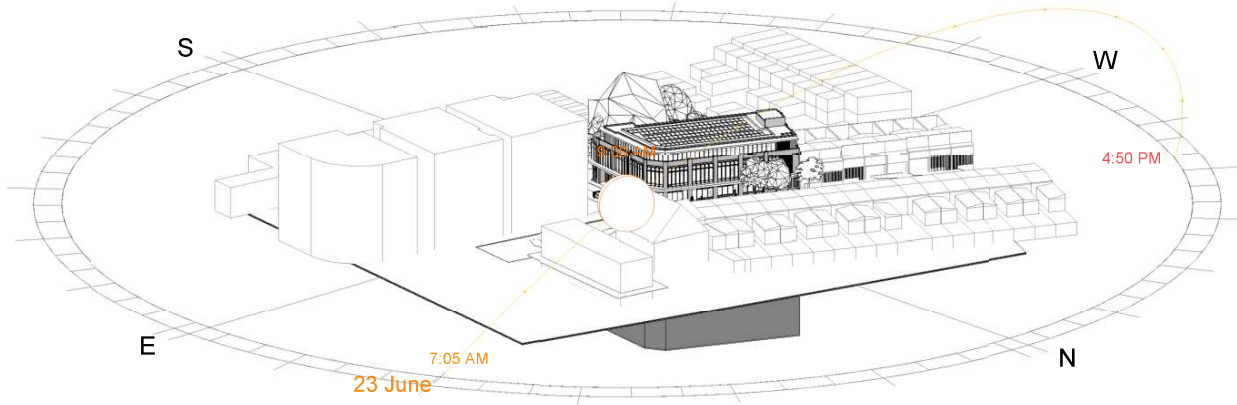

1 Sun eye view - 2023 Jun-23, 09-40

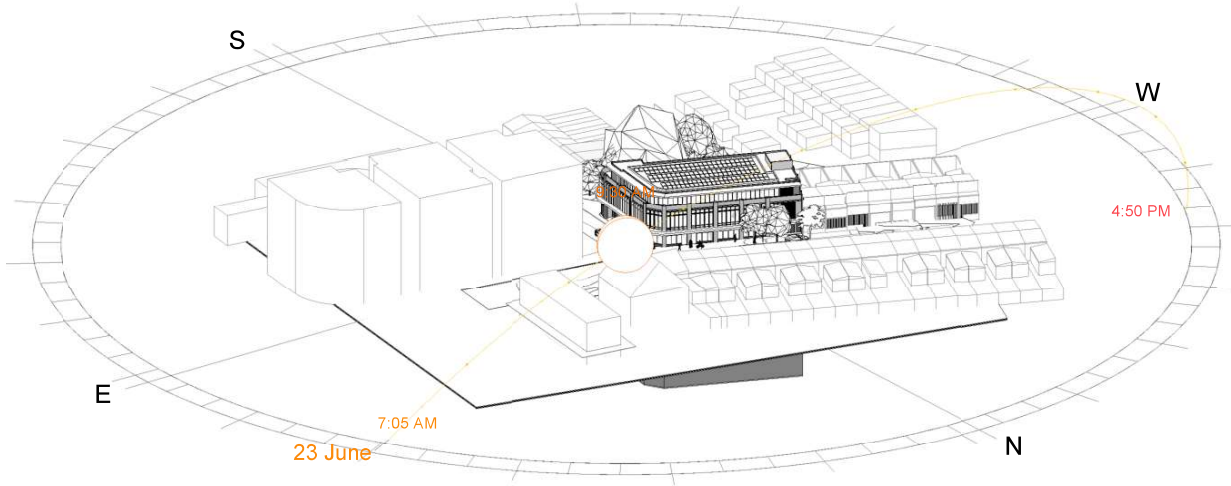

2 Sun eye view - 2023 Jun-23, 09-40

REV	DESCRIPTION	DATE	APP.
1	ISSUED TO COUNCIL	07.03.24	AC
2	ISSUED TO COUNCIL	15.05.24	AC

Client
STASIA PTY LTD

Project
Cleveland St Mixed Use

Drawing
SUN EYED DIAGRAM - WINTER

A1 Scale
Project 220098
Issue 2

Number DD - DR - AR - DA 324

Details
Copyright Conrad Gargett, ACN 636 450 373 ABN 61 631 460 375
Do not scale this drawing and verify all dimensions and levels on site.
Nominated Architect: Lawrence Toaloo NSW Reg. 10255,
Nominated Architect: Oliver Condon NSW Reg. 11726,
Nominated Architect: Laura Cookburn NSW Reg. 6361.



DEVELOPMENT APPROVAL

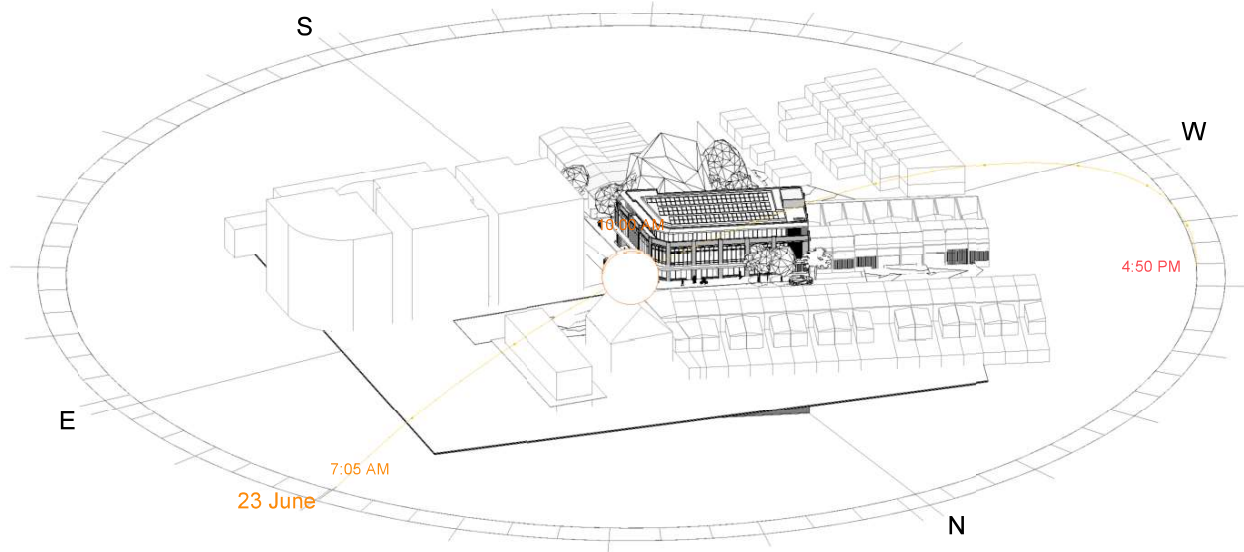

1 Sun eye view - 2023-Jun-23, 10:40

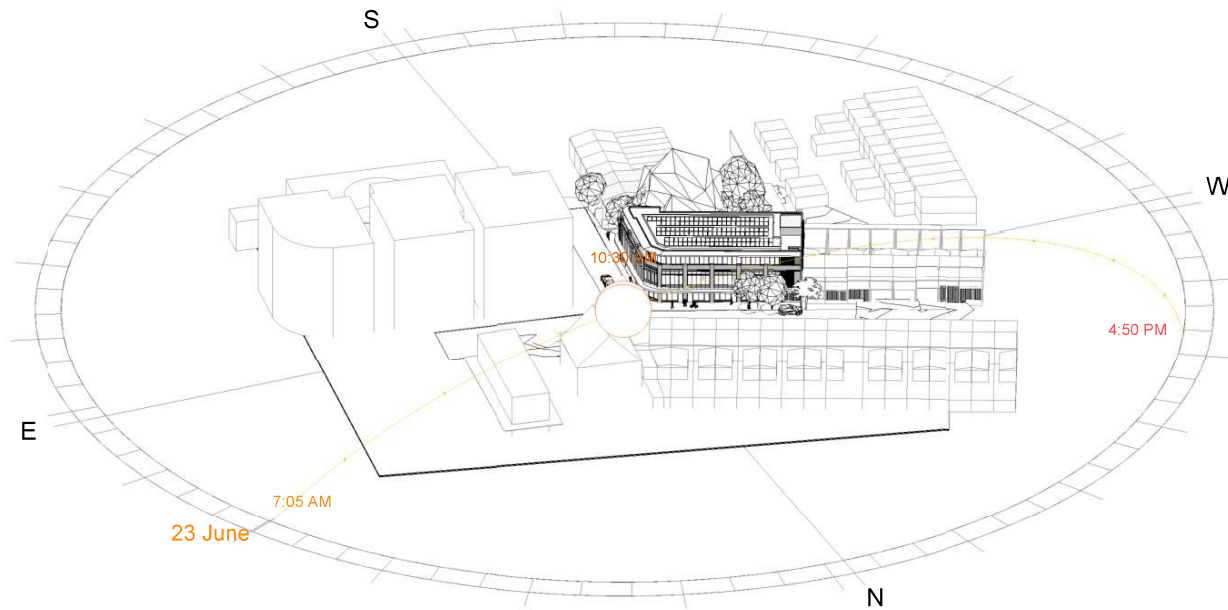

2 Sun eye view - 2023-Jun-23, 10:30

Revision	DESCRIPTION	DATE	APP.
1	ISSUED TO COUNCIL	07.03.24	AC
2	ISSUED TO COUNCIL	15.05.24	AC

Client
STASIA PTY LTD

Project
Cleveland St Mixed Use

Drawing
SUN EYED DIAGRAM - WINTER

A1 Scale
Project 220098
Issue 2
Number DD - DR - AR - DA 325

Details
Copyright Conrad Gargett, ACN 636 450 373 ABN 61 631 465 375
Do not scale this drawing and verify all dimensions and levels on site.
Nominated Architect: Lawrence Toaloo NSW Reg. 10255,
Nominated Architect: Ollian Condonson NSW Reg. 11726,
Nominated Architect: Laura Cookburn NSW Reg. 6360.



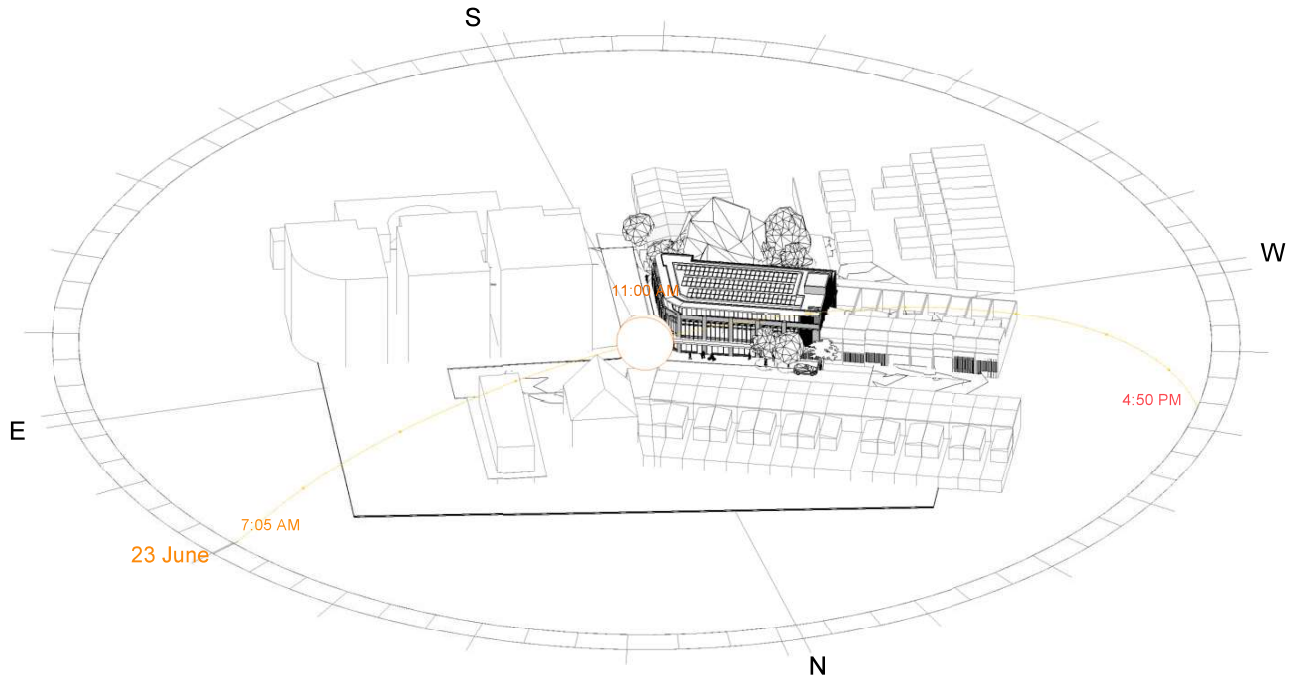

1 Sun eye view - 2023 Jun-23, 11:00

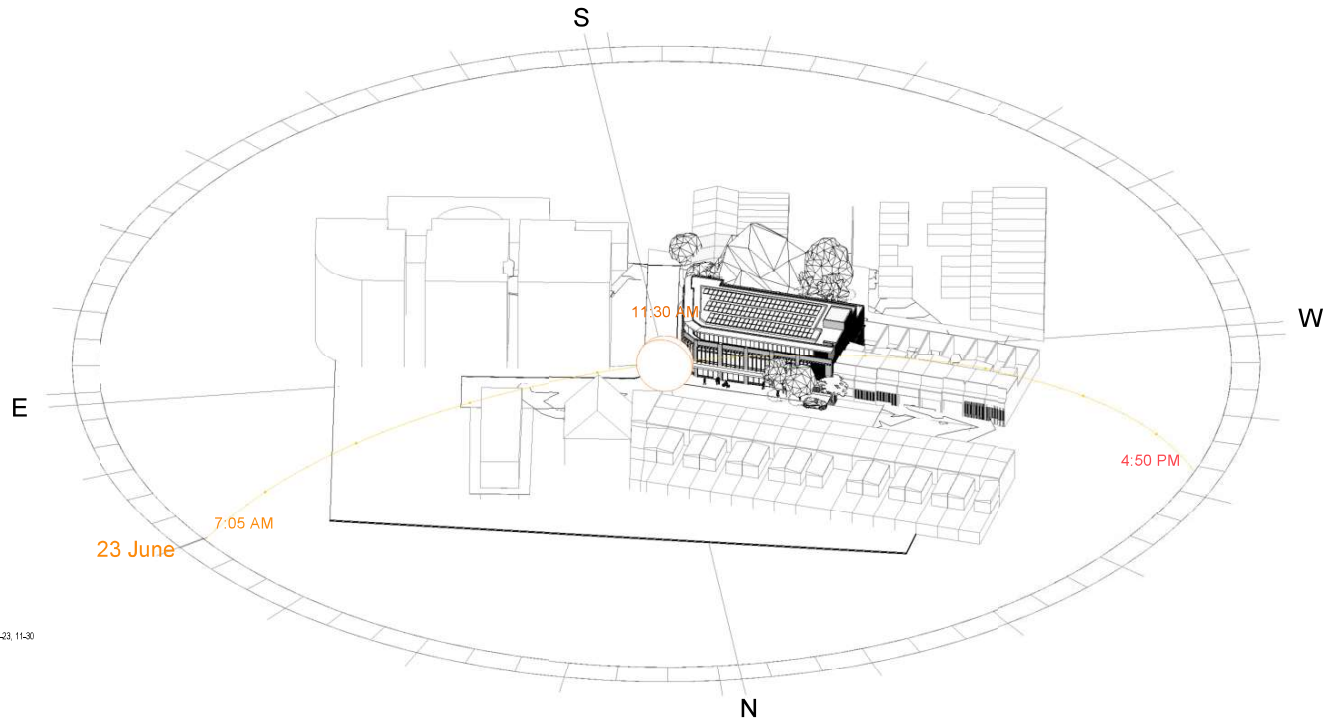

2 Sun eye view - 2023 Jun-23, 11:30

REV	DESCRIPTION	DATE	APP.
1	ISSUED TO COUNCIL	07.03.24	AC
2	ISSUED TO COUNCIL	15.05.24	AC

Client
STASIA PTY LTD

Project
Cleveland St Mixed Use

Drawing
SUN EYED DIAGRAM - WINTER

A1 Scale
Project 220098
Issue 2
Number DD - DR - AR - DA 326

Details
Copyright Conrad Gargett. ACN 636 450 373 ABN 61 631 465 375
Do not scale this drawing and verify all dimensions and levels on site.
Nominated Architect: Lawrence Tomko NSW Reg. 10255,
Nominated Architect: Ollian Condonson NSW Reg. 11726,
Nominated Architect: Laura Cookburn NSW Reg. 6360.



DEVELOPMENT APPROVAL

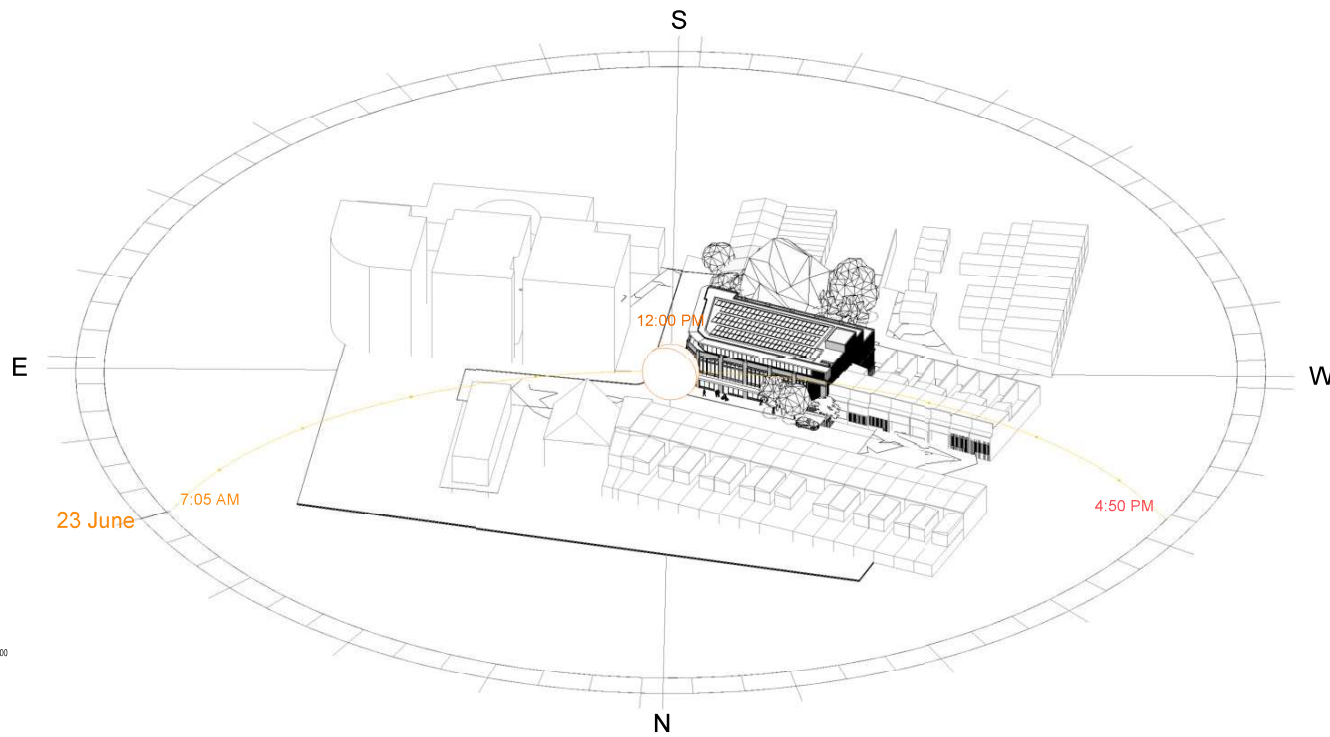

1 Sun eye view - 2023 Jun-23, 12:00

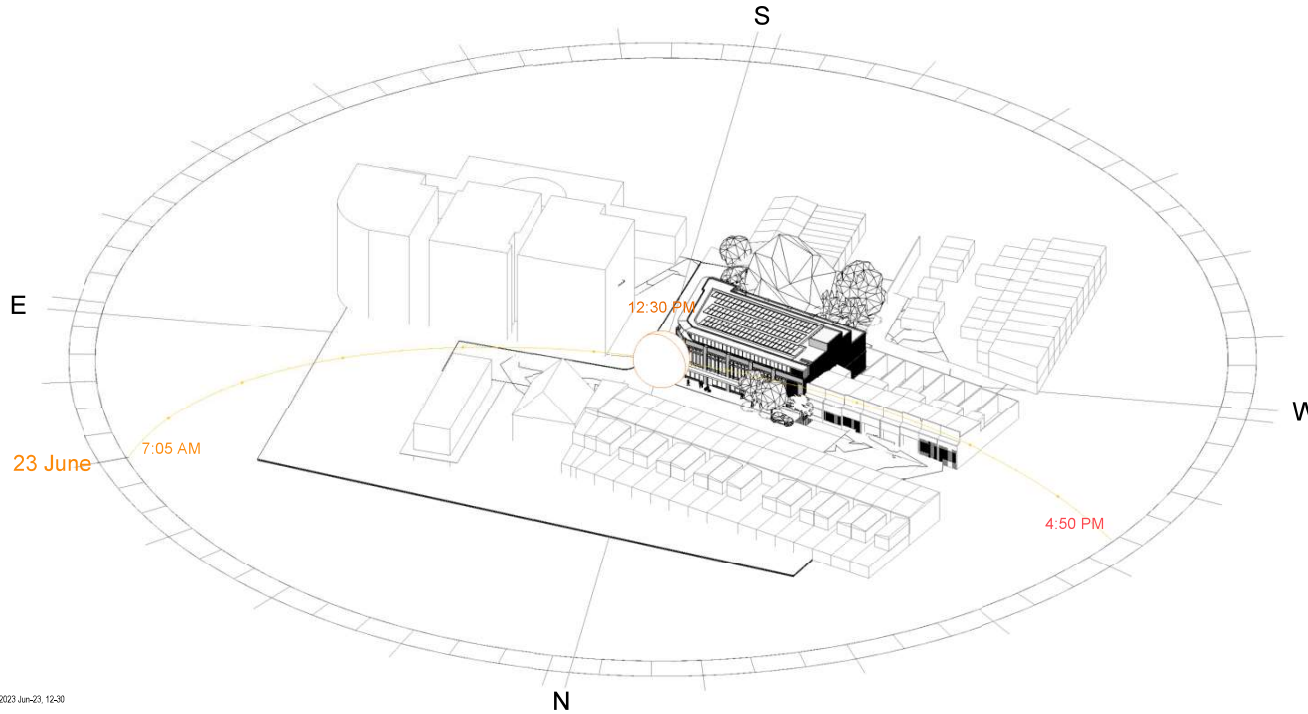

2 Sun eye view - 2023 Jun-23, 12:30

REV	DESCRIPTION	DATE	APP.
1	ISSUED TO COUNCIL	07.23.24	AC
2	ISSUED TO COUNCIL	15.05.24	AC

Client
STASIA PTY LTD

Project
Cleveland St Mixed Use

Drawing
SUN EYED DIAGRAM - WINTER

A1 Scale
Project 220098
Issue 2
Number DD - DR - AR - DA 327

Details
Copyright Conrad Gargett, ACN 636 450 373 ABN 61 636 450 373
Do not scale this drawing and verify all dimensions and levels on site.
Nominated Architect: Lawrence Toaloo NSW Reg. 10255,
Nominated Architect: Ollian Condonson NSW Reg. 11726,
Nominated Architect: Laura Cookburn NSW Reg. 6360.



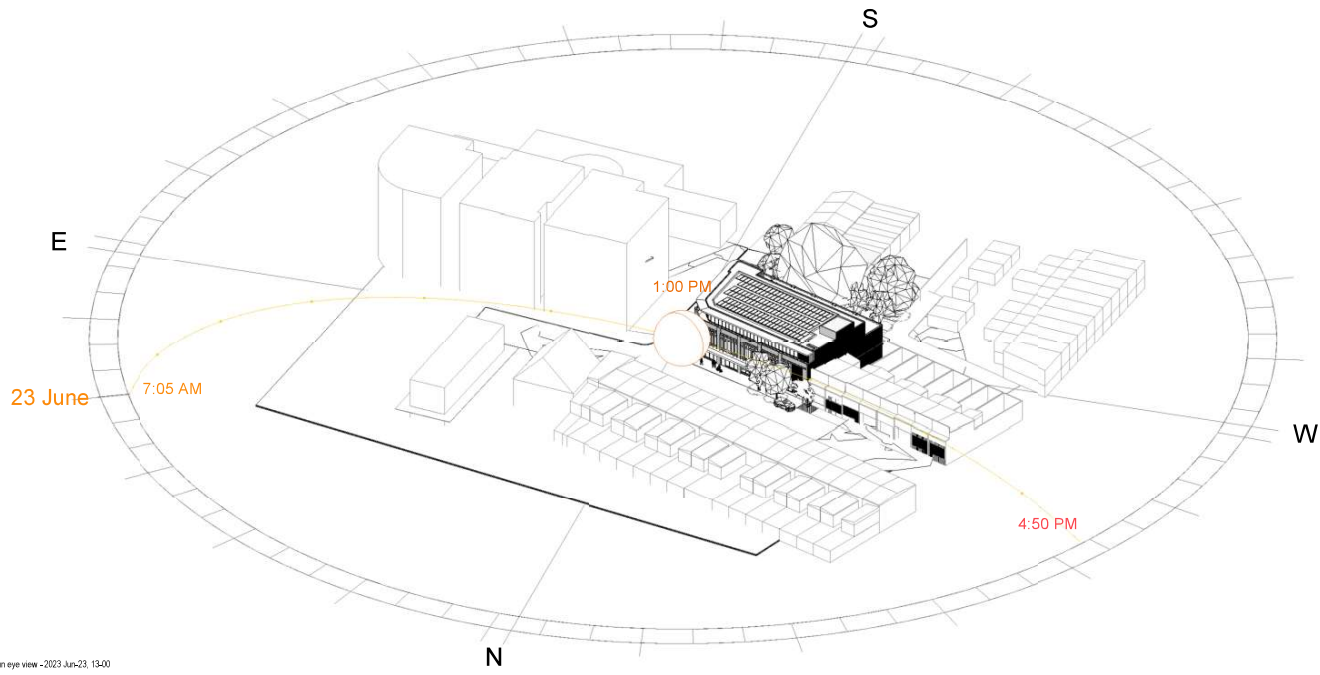

1 Sun eye view - 2023 Jun-23, 13:00

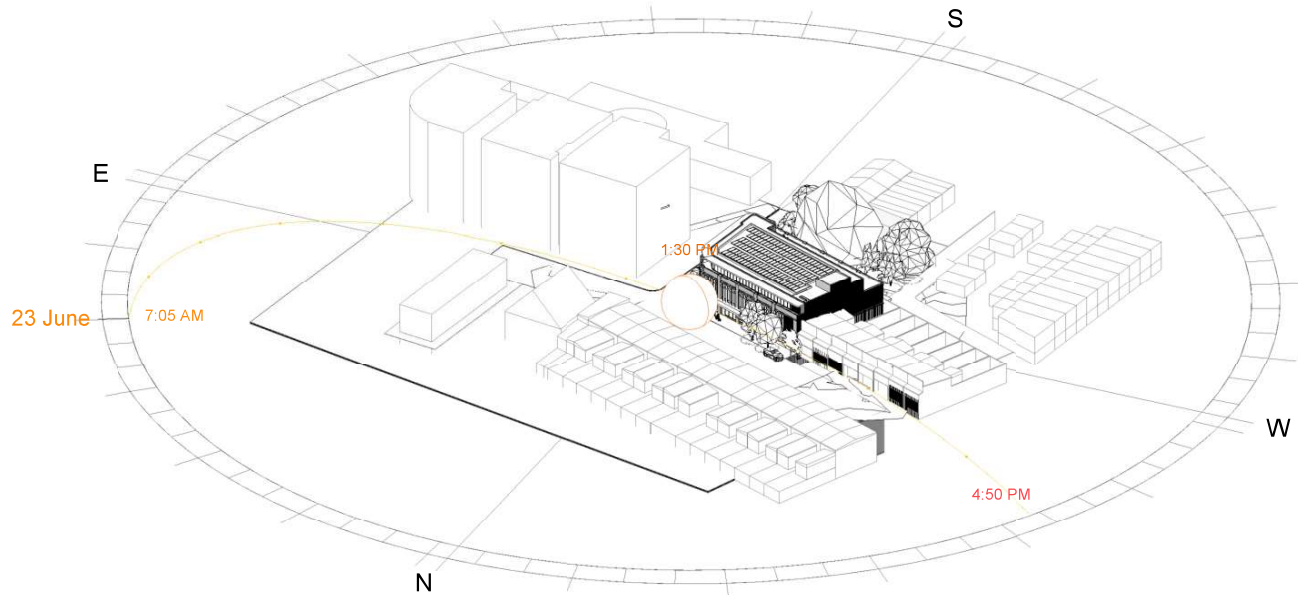

2 Sun eye view - 2023 Jun-23, 13:30

REV	DESCRIPTION	DATE	APP.
1	ISSUED TO COUNCIL	07.03.24	AC
2	ISSUED TO COUNCIL	15.05.24	AC

Client
STASIA PTY LTD

Project
Cleveland St Mixed Use

Drawing
SUN EYED DIAGRAM - WINTER

A1 Scale
Project 220098
Issue 2

Number DD - DR - AR - DA 328

Details
Copyright Conrad Gargett. ACN 636 450 373 ABN 61 636 450 373.
Do not scale this drawing and verify all dimensions and levels on site.
Nominated Architect: Lawrence Toaloo NSW Reg. 10255.
Nominated Architect: Ollian Condonson NSW Reg. 11726.
Nominated Architect: Laura Cookburn NSW Reg. 6360.



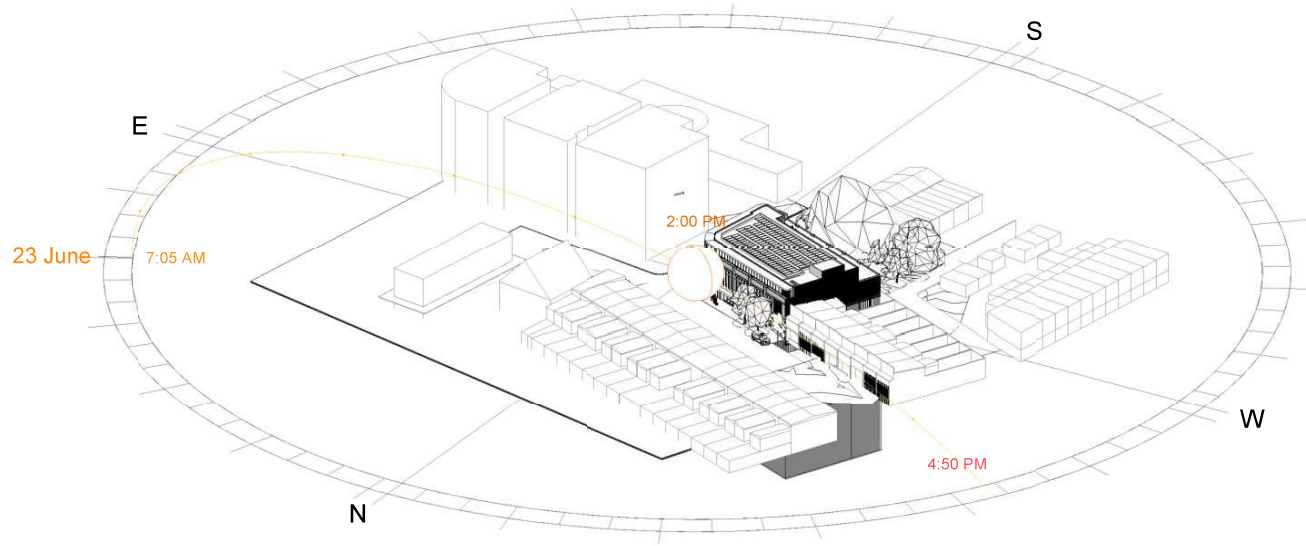

1 Sun eye view - 2023 Jun-23, 14:00

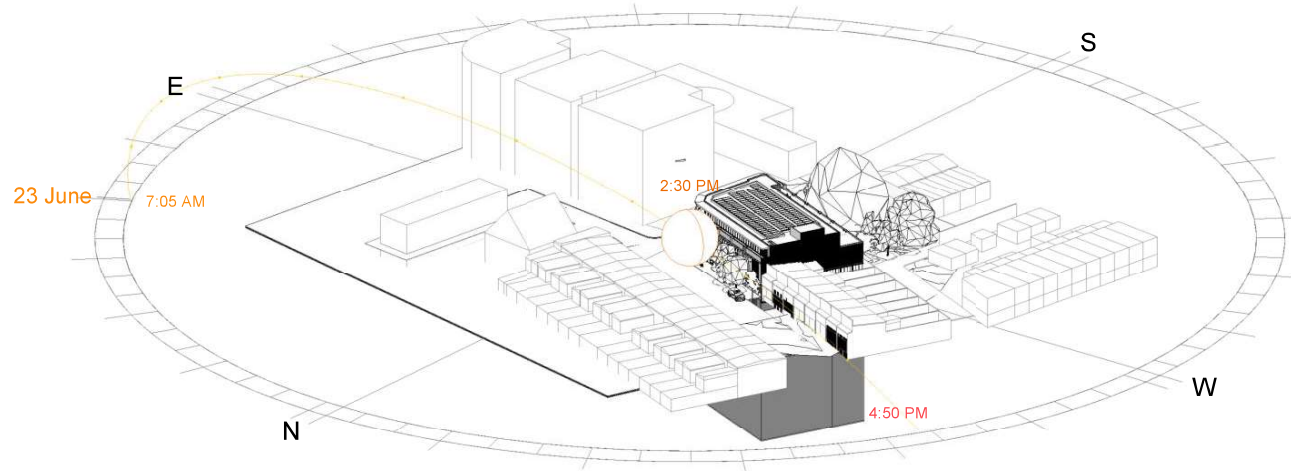

2 Sun eye view - 2023 Jun-23, 14:30

REV	DESCRIPTION	DATE	APP.
1	ISSUED TO COUNCIL	07.03.24	AC
2	ISSUED TO COUNCIL	15.05.24	AC

Client
STASIA PTY LTD

Project
Cleveland St Mixed Use

Drawing
SUN EYED DIAGRAM - WINTER

A1 Scale
Project 220098
Issue 2

Number DD - DR - AR - DA 329

Details
Copyright Conrad Gargett. ACN 636 450 373 ABN 61 636 450 375
Do not scale this drawing and verify all dimensions and levels on site.
Nominated Architect: Lawrence Tombo NSW Reg. 10253,
Nominated Architect: Ollian Condonson NSW Reg. 11726,
Nominated Architect: Laura Cookburn NSW Reg. 6360.



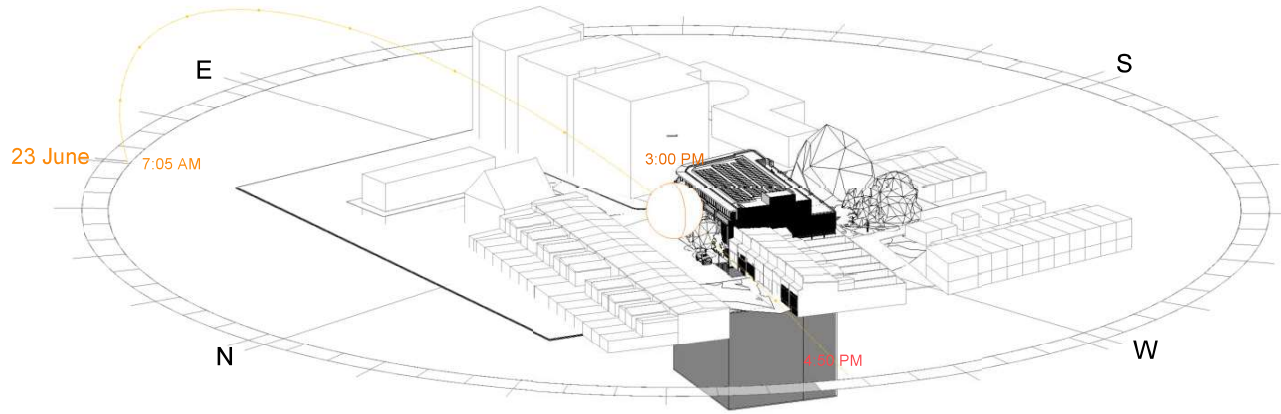

1 Sun eye view - 2023 Jun-23, 15:00

REV	DESCRIPTION	DATE	APP.
1	ISSUED TO COUNCIL	07.03.24	AC
2	ISSUED TO COUNCIL	15.05.24	AC

Client
STASIA PTY LTD

Project
Cleveland St Mixed Use

Drawing
SUN EYED DIAGRAM - WINTER

A1 Scale
Project 220098
Issue 2

Number DD - DR - AR - DA 330

Details
Copyright Conrad Gargett. ACN 636 463 373 ABN 61 631 465 375
Do not scale this drawing and verify all dimensions and levels on site.
Nominated Architect: Lawrence Tomko NSW Reg. 10255,
Nominated Architect: Gillian Condon NSW Reg. 11726,
Nominated Architect: Laura Cookburn NSW Reg. 6361.



DEVELOPMENT APPROVAL